

44424049	DATA SHEET	
Valid from: 03.07.2024	EPIC® H-Q 12 SC / H-Q 12 BC	

Description

- With 12 working contacts in the proven crimp technology and one PE contact with screw termination.
- High performance crimping contacts
- PE contact with screw connection



General Characteristics

Series	H-Q 12
Version	Male/Female(Article 44424049 / 44424050)
Number of Contacts	12+PE
Termination Methods	Crimp termination: 0,14 - 2.5 mm ²
Temperature Range	-40°C to +120°C, short-term up to +125°C

Mechanical Characteristics

Cycle of mechanical operation	200
-------------------------------	-----

Electrical Characteristics

Rated Voltage, IEC	400 V
Rated Voltage, UL	600 V
Rated Voltage, CSA	600 V
Rated Impulse Voltage	6 kV
Rated Current, IEC	10 A
Rated Current, UL	14 A
Rated Current, CSA	10 A
Contact Resistance	< 3 mOhm
Degree of Soiling	3

Materials and Surfaces

Contacts	Copper alloy, hard silver/gold-plated
Flammability Class according to UL 94	V0

Approvals

UL-Approval, E-File-Number	E75770
----------------------------	--------

Standard

Safety Standard	IEC 61984, UL 1977
-----------------	--------------------

Creator: JOKR1/PDP Released: IVSE1/PDP	Document: DB44424049EN Version: 02	Page 1 of 2
---	---------------------------------------	-------------

44424049	DATA SHEET	
Valid from: 03.07.2024	EPIC® H-Q 12 SC / H-Q 12 BC	

Technical Drawings

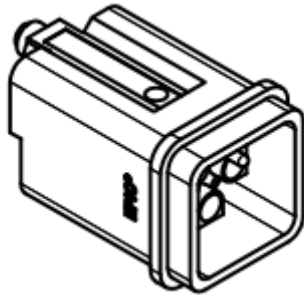

Polbild - M

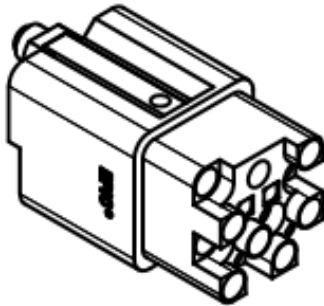
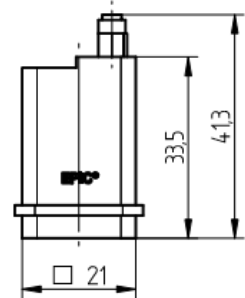
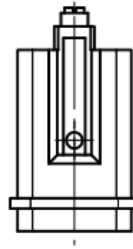

Polbild - F

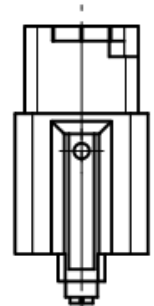
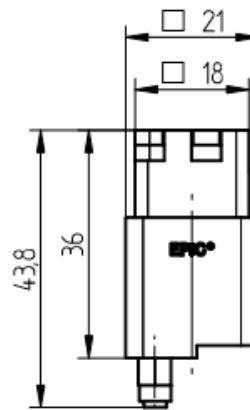

Industrial machinery and plant engineering

Info

Compact, powerful standard insert
Space saving, crimping contact

Application range

Machine and equipment manufacturing
Control engineering

Remark

Photographs are not to scale and do not represent detailed images of the respective products.

Creator: JOKR1/PDP Released: IVSE1/PDP	Document: DB44424049EN Version: 02	Page 2 of 2
---	---------------------------------------	-------------